

# MK103 SOUND-TO-LIGHT UNIT - LED LICHTORGEL - ORGUE LUMINEUX SIMPLE - EINFACHE LICHTORGEL - ÓRGANO DE LUZ CON LEDS

START

1

Resistor - Weerstand - Résistance - Widerstand - Resistencia - Motstand - Vastus - Resistenze

- ◇ R1 : 10K (Brown, Black, Orange) - (Bruin, Zwart, Oranje) - (Brun, noir, Orange) - (Braun, Schwarz, Orange) - (Brun, Svart, Orange) - (Ruskea, Musta, Oranssi) - (Marrón, Negro, Naranjado) - (Castanho, Preto, Laranja) - (Marrone, Nero, Aranciato)
- ◇ R2 : 330K (Orange, Orange, Yellow) - (Oranje, Oranje, Geel) - (Orange, Orange, Jaune) - (Orange, Orange, Gelb) - (Orange, Orange, Gul) - (Oranssi, Oranssi, Keltainen) - (Naranjado, Naranjado, Amarello) - (Laranja, Laranja, Amarelo) - (Aranciato, Aranciato, Giallo)
- ◇ R3 ... R5 : 100K (Brown, Black, Yellow) - (Bruin, zwart, Geel) - (Brun, noir, Jaune) - (Braun, Schwarz, Gelb) - (Brun, Svart, Gul) - (Ruskea, Musta, Keltainen) - (Marrón, Negro, Amarillo) - (Castanho, Preto, Amarelo) - (Marrone, Nero, Giallo)
- ◇ R6 ... R9 : 47E (Yellow, Purple, Black) - (Geel, Paars, Zwart) - (Jaune, Violet, Noir) - (Gelb, Violet, Schwarz) - (Gul, Lila, Svart) - (Keltainen, Purppura, Musta) - (Amarillo, Morado, Negro) - (Amarelo, Violeta, Preto) - (Giallo, Viola, Nero)
- ◇ R10 ... R12 : 1M5 (Brown, Green, Green) - (Bruin, Groen, Groen) - (Brun, Vert, Vert) - (Braun, Grün, Grün) - (Brun, Grön, Grön) - (Ruskea, Vihreä, Vihreä) - (Marrón, Verde, Verde) - (Castanho, Verde, Verde) - (Marrone, Verde, Verde)
- ◇ R13, R14 : 47K (Yellow, Purple, Orange) - (Geel, Paars, Oranje) - (Jaune, Violet, Orange) - (Gelb, Violet, Orange) - (Gul, Lila, Orange) - (Keltainen, Purppura, Oranssi) - (Amarillo, Morado, Naranjado) - (Amarelo, Violeta, Laranja) - (Giallo, Viola, Aranciato)

2 LED

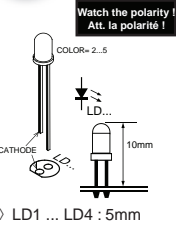

3 Transistor

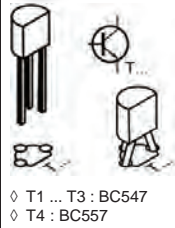

4 Ceramic capacitors

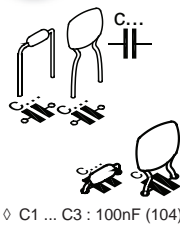

5 Electrolytic capacitors

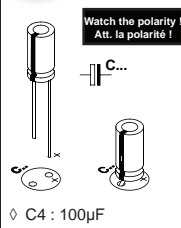

6 Horizontal Trimmer

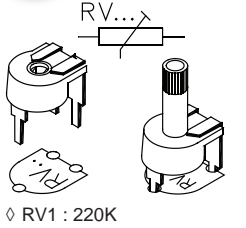

7 Microphone

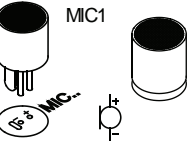

8

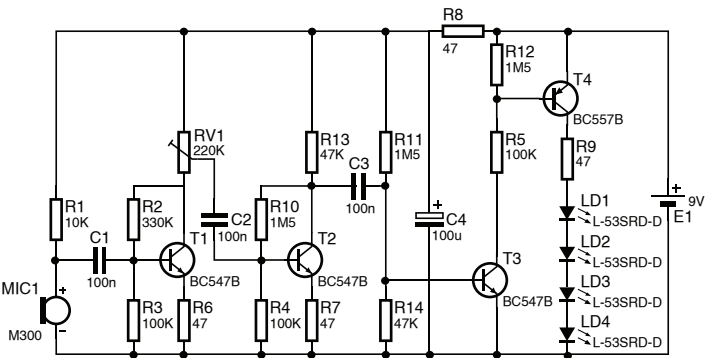
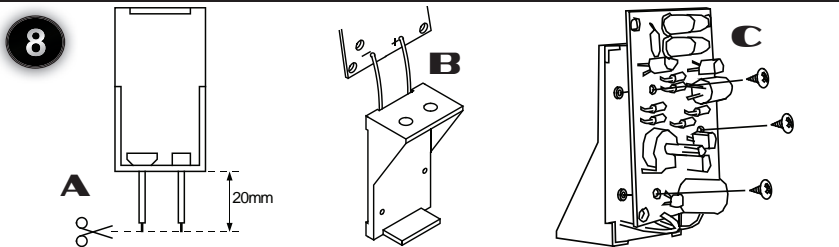

# MK102 FLASHING LEDS - KNIPPERENDE LEDS - LEDS CLIGNOTANTES - BLINKENDE LEDS - LEDS INTERMITENTES

START

1

Resistor - Weerstand - Résistance - Widerstand - Resistencia - Motstand - Vastus - Resistenze

- ◇ R1, R2 : 1K (Brown, Black, Red) - (Bruin, Zwart, Rood) - (Brun, Noir, Rouge) - (Braun, Schwarz, Rot) - (Brun, Svart, Röd) - (Ruskea, Musta, Punainen) - (Marrón, Negro, Rojo) - (Castanho, Preto, Encarnado) - (Marrone, Nero, Rosso)
- ◇ R3, R4 : 10K (Brown, Black, Orange) - (Bruin, Zwart, Oranje) - (Brun, noir, Orange) - (Braun, Schwarz, Orange) - (Brun, Svart, Orange) - (Ruskea, Musta, Oranssi) - (Marrón, Negro, Naranjado) - (Castanho, Preto, Laranja) - (Marrone, Nero, Aranciato)

2 Trimmer

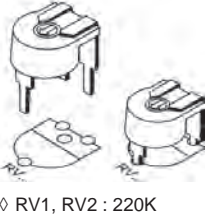

3 Transistor

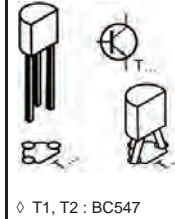

4 LED

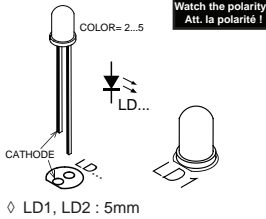

5 Electrolytic capacitors

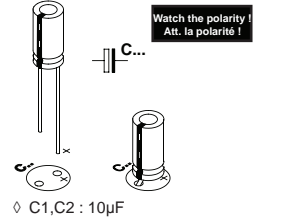

6 Battery snap

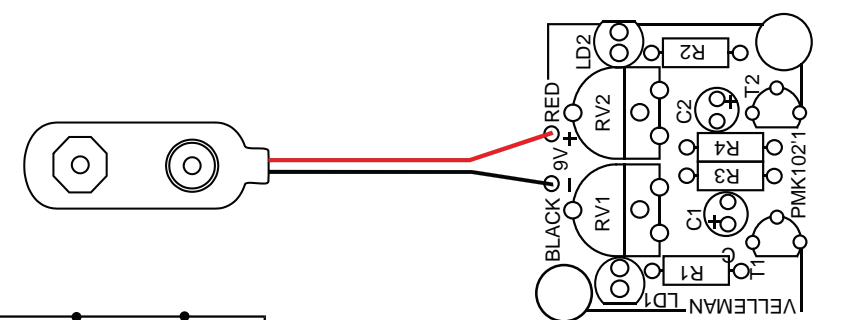
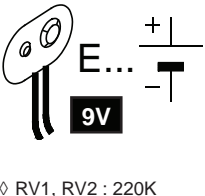

◇ RV1, RV2 : 220K

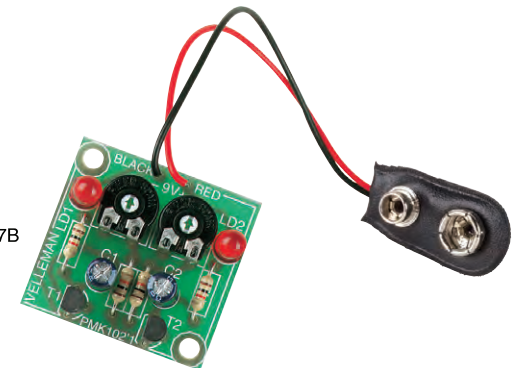
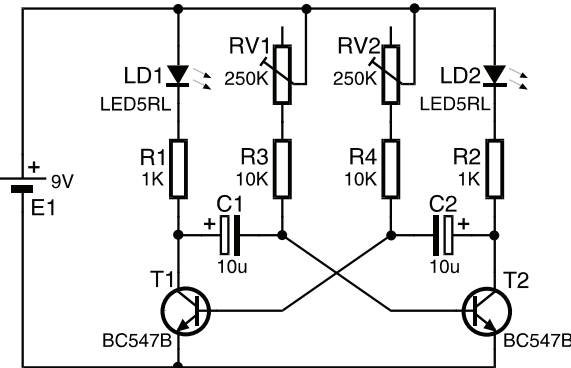

# HOW TO SOLDER? - HOE SOLDEREN ? - COMMENT SOUDER? - WIE LÖTEN? - ¿CÓMO SOLDAR?



Wipe tip - Reinig de punt - Nettoyez la panne - Reinigen Sie die Spitze - Limpie la punta

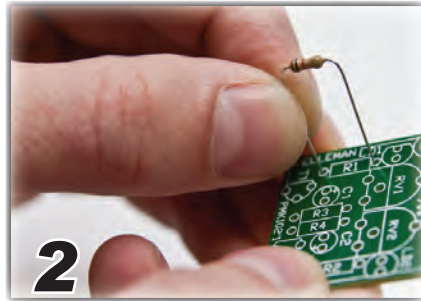

Insert part against PCB - Monteer het onderdeel tot tegen het printplaatje - Montez le composant contre le circuit imprimé - Montieren Sie das Bauteil bis gegen die Leiterplatte - Ponga la pieza junto al CI

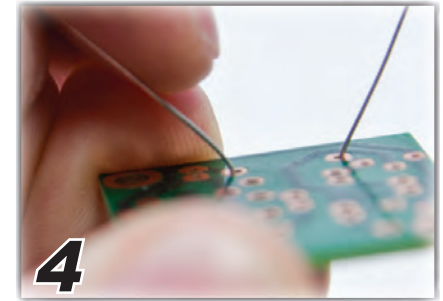
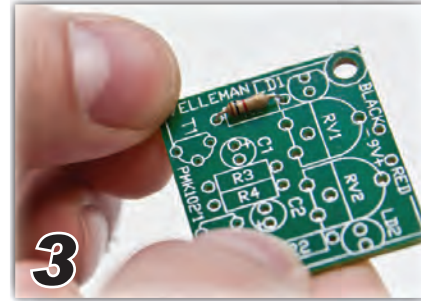

Bend leads - Plooi de aansluitdraden - Pliez les fils de connexion - Biegen Sie das Drahtende um - Pliegue los hilos

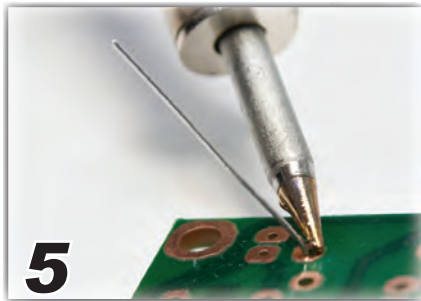

Heat part lead & PCB pad - Verwarm het uiteinde van de aansluitdraad en het printplaatje - Réchauffez l'extrémité du fil de connexion et le circuit imprimé - Erhitzen Sie den Anschlussdraht und die Lötstelle - Caliente una parte del hilo junto a la placa CI

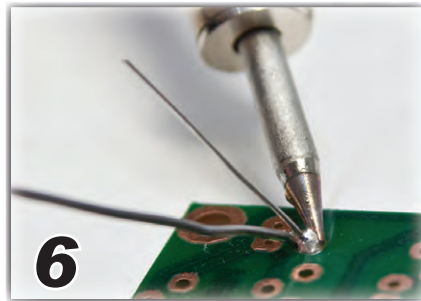

Apply solder - Breng soldeersel aan - Appliquez de la soudure - Führen Sie Lötzinn zu - Haga la soldadura

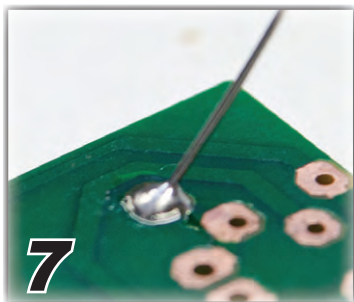

Correct joint - Correcte soldeerverbinding - Joint de soudure correct - Korrekte Lötverbindung - Soldado correcto

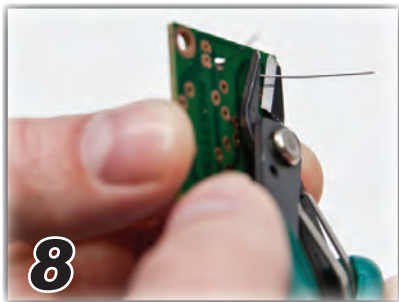

Cut close to PCB - Knip af tot tegen het printplaatje - Coupez jusqu'au bord du circuit imprimé - Zwicken Sie die Anschlussdrähte knapp über den Lötverbindungen ab - Corte cerca de la placa CI

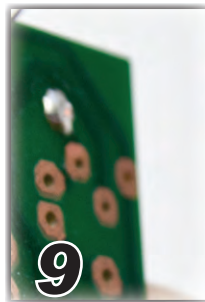

Inspect - Controleer - Vérifiez - Überprüfen Sie - Compruebe la soldadura

## Bad solderings - slechte solderingen - mauvaises soudures - Schlechte Lötstellen - Malas soldaduras

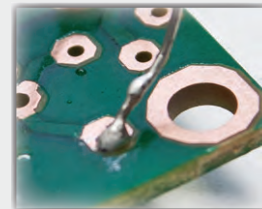

Too little solder - Te weinig soldeersel - Pas assez de soudure - Zu wenig Lot - Poco soldado

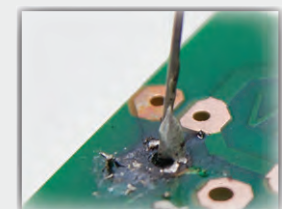

Too much heat - Te warm - Chaleur de soudure trop élevée - Zu warm - Demasiada temperatura

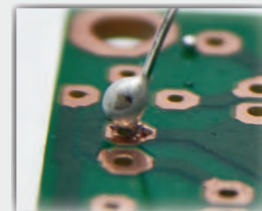

Bad contact - Slecht contact - Mauvais contact - Schlechter Kontakt - Mal contacto

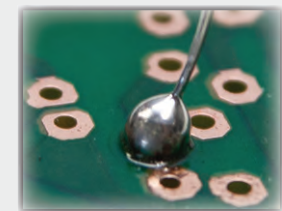

Too much solder - Te veel soldeersel - Trop de soudure - Zu viel Lot - Soldado en exceso